

Videojet 2300

462188-10
AA, 2010 5

2010 5 Videojet Technologies

Videojet

Videojet Technologies
Videojet

Videojet
CLARiTY® CLARiSOFT® CLARiNET®

Videojet Technologies

1500 Mittel Boulevard
Wood Dale, IL
60191-1073 USA
www.videojet.com

1-800-843-3610
1-800-582-1343
630-616-3629

-



FCC 15

1)

2)



FCC 15 A

FCC A



Pour la Clientèle du Canada

Le present appareil numerique n'emet pas de bruits radioelectriques depassant les limites applicables aux appareils numerique de la class A prescrites dans le Reglement sur le brouillage radioelectrique edicte par le ministere des Communications du Canada.

Cet équipement est certifié CSA.

CE

EU EMC 2004/108/EC

EN61000-6-2:2005

BS EN 55022:1998 +A1 2000
+A2 2003 A

IT

BS EN 55024:1998+A1 2001
+A2 2003

IT

EN61000-3-2:2000

16A

EN61000-3-3:1995 +A1 2001

16A

EC 2006/95/EEC

EN60950-1:2006 IEC
60950-1:2005

1-800-843-3610

Videojet Technologies
Videojet Technologies

Videojet Technologies
1500 Mittel Boulevard
Wood Dale, IL 60191-1073 U.S.A.
1-800-843-3610
1-800-582-1343
630-616-3629
www.videojet.com

Total Source

Total Source® TOTAL SERVICE PLUS RELIABILITY
Videojet Technologies

Total Source

Videojet *Total Source*®

-
-
-
-
-
-
-
-
-
-

Videojet Technologies

Videojet Technologies

Videojet Technologies
1-800-843-3610
Videojet Videojet

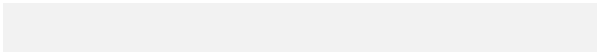

..... i
 i
Pour la Clientèle du Canada ii
 ii
 iii
 iii
 iv

1 —
 Videojet 2300 1-1
 1-1
 1-2

2 —
 2-1
 2-2
 2-2
 2-2
 2-3
 2-4
 2-4
 2300 2-6
 2-6
 / 2-7
 2-9
 2-10
 2-10

3 — **CLARITY®**
 3-1
 CLARITY® 3-2
 3-2
 3-2
 3-5

4 —

..... 4-1

..... 4-4

..... 4-5

LED 4-6

..... 4-6

..... 4-6

..... 4-7

..... 4-11

..... 4-13

..... 4-14

'A' 4-15

'B' 4-15

5 —

..... 5-1

..... 5-1

..... 5-5

..... 5-5

..... 5-6

..... 5-9

/ 5-10

..... 5-11

..... 5-13

..... 5-14

..... 5-18

..... 5-20

Videojet 2300

Videojet 2340 2350 2360

2300 CLARiTY®

(PC)

PC

2300

1-1

Videojet 2340	17	X 2000
Videojet 2350	50	X 2000
Videojet 2360	70	X 2000

1-1

Videojet 2300

" "

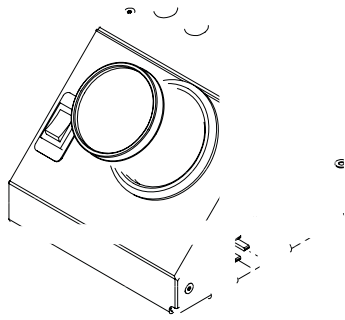

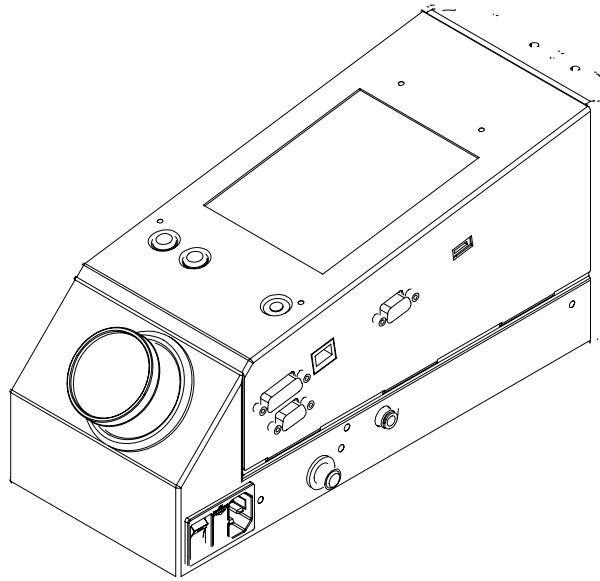

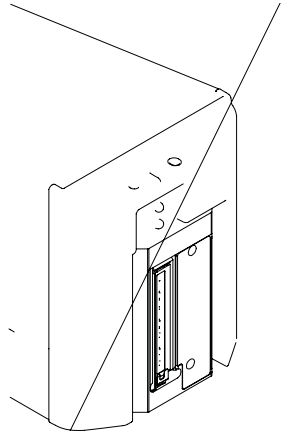

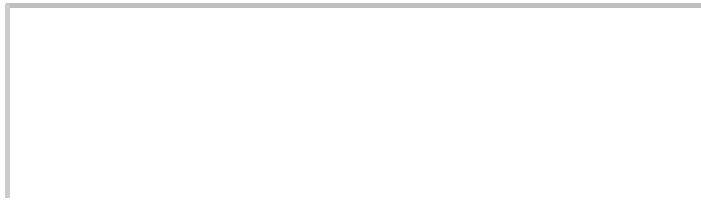

-
-
-
-
-
- 2003
-
-



Videojet Technologies
/

-
-
- " "
-



" "

-
- -
 - " "
 -



AC OFF (O)
OFF





ANSI/NFPA 70-1993 500

MSDS



56°C (133°F) Videojet

-22°C (-8°F)





15





(MSDS)

MSDS
MSDS

MSDS

MSDS
800-843-3610
Videojet

Videojet
Videojet



MSDS

2300

/



60947-3 IEC 60947-2

IEC



Videojet 2340 2350 2360

" "





Videojet 2340 2350 2360

-

/



/



Videojet 2340/2350/2360



/ MSDS

- CLARITY®
-
-

CLARITY®



CLARITY®

CLARITY®

3-1



3-1 CLARITY®

3-2

3-3

3-1

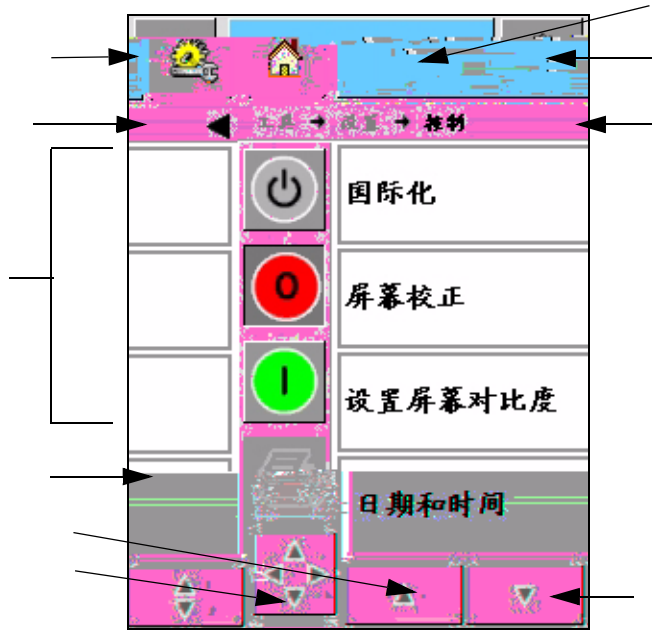

3-2

	Videojet 2340/2350/2360
	3-4 " "
	• •

3-1

CLARITY®

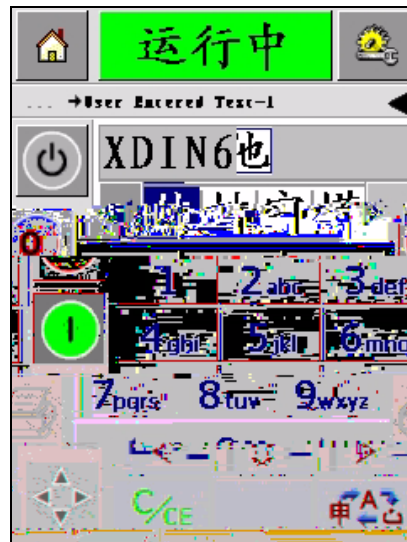

3-5

3-2

1	1...?/:!-&;+#()'"_@\$ø£€¥%<>¿¡§=α
2	ABC2abcÄÅÄÅÄÅÆÇäåääãääæçø
3 def	DEF3defÈÉÊËèéëê€
4 ghi	GHI4ghiİıİıİı
5 jkl	JKL5jkl£
6 mno	MNO6mnoÖÛÔÓØÑöðóøñ

3-2

-

	PQRS7pqrs\$B\
	TUV8tuvÛÛÛÛÛÛÛÛ
	WXYZ9wxyz
	0*
	/

3-2

-



-

-

-

LEI

-

-

-

4-1 4-1

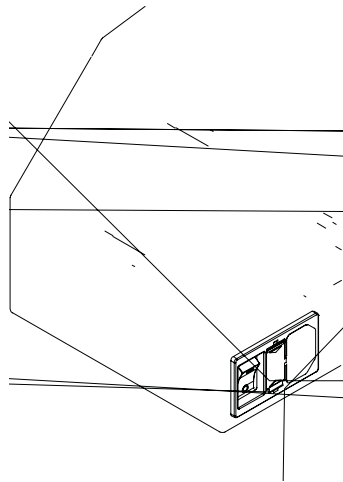

1

90

2

CLARITY®

3

CLARITY®

4-3

4-3

4



4-3

5

4-3



2300

4-1

Videojet 2340	2.5
Videojet 2350	3.5
Videojet 2360	4.5

4-1



4-4

Videojet 2340 2350 2360

/

/

-
-
-

CLARITY®

4-5

4-5

-

4

LED

CLARITY®
4-6

LED



LED

4-6 LED

LED 4-2

LED	
	LED
	CLARITY®

4-2 LED

-
-
-

4-7

4-7

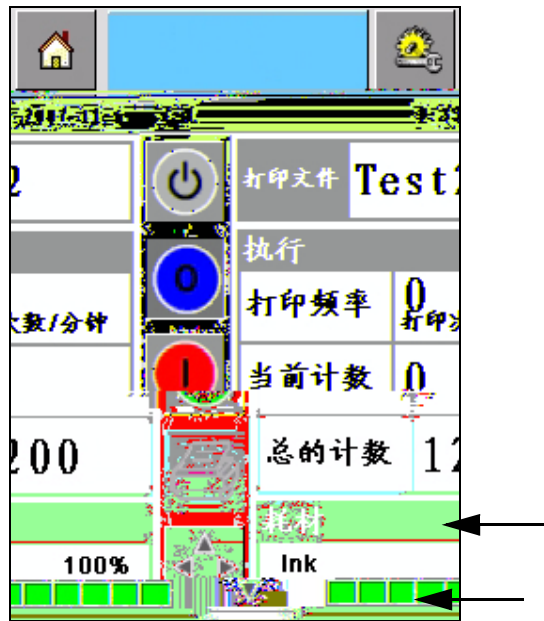

4-7

4-3

5% CLARITY®
4-7

4-4

	175	365
Videojet 2340	M512-4	
Videojet 2350	M512-4	M512-K
Videojet 2360	M512-4	M512-K

4-4

1

4-7

4-7

4-8



4-8

2

4-8

4-9

4-9

3



4-9

4

" "

4-10

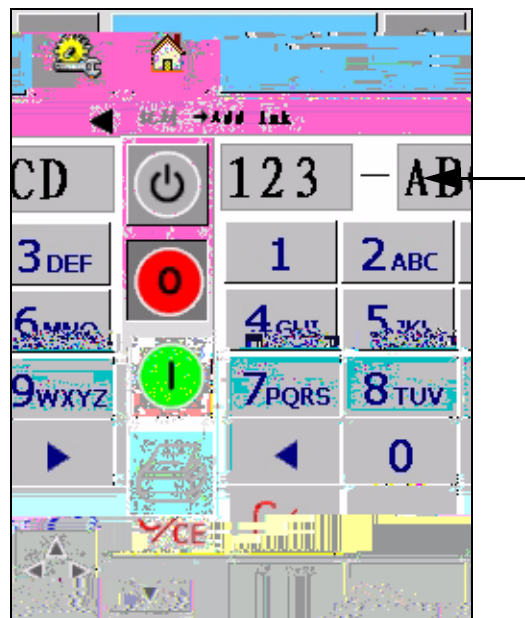

4-10

4-10

4-11



4-11



5 CLARiTY®

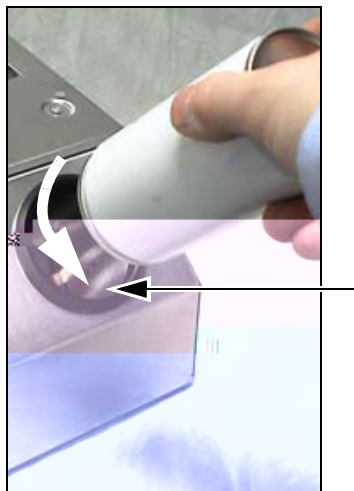

4-12

- a.
- b.
- c.

4-13



4-13

1

4-12

4-11
4-15

4-14

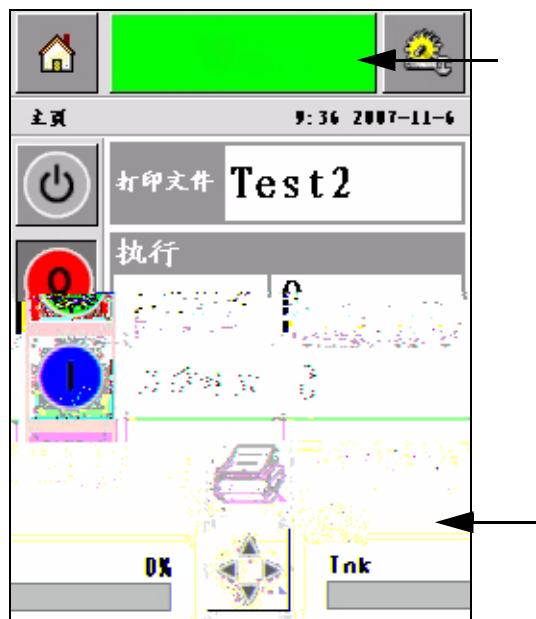

4-14

2



4-15

3

4-16

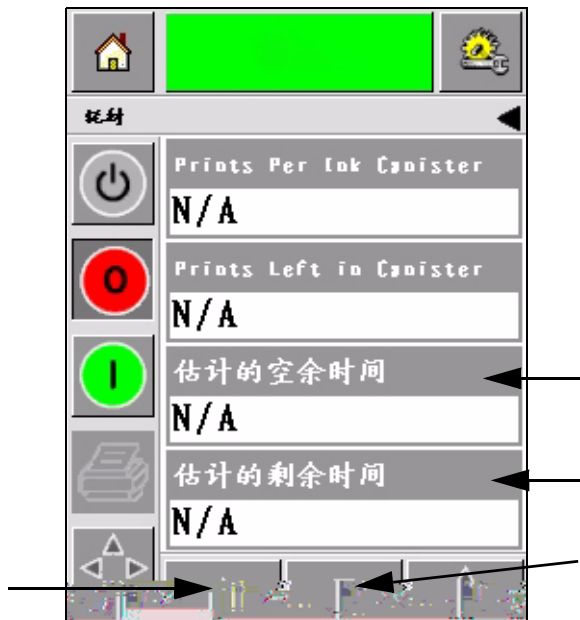

4-16

-
-
-
-
-

2300

4-5

		100%
Videojet 2340	10 / 0.6 /	550 / 33 /)
Videojet 2350	10 / 0.6 /	550 / 33 /)
Videojet 2360	10 / 0.6 /	550 / 33 /)

4-5

-
-
-
-

-
-

2

4-17

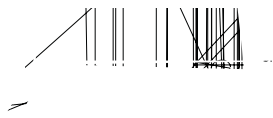
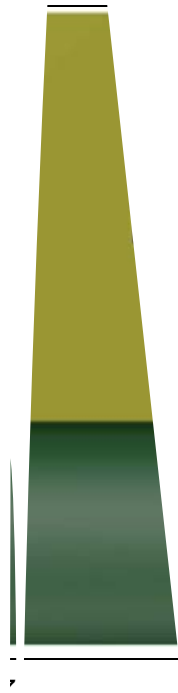

4-16

4-20

A

•

•

A

'B'

'B'

B

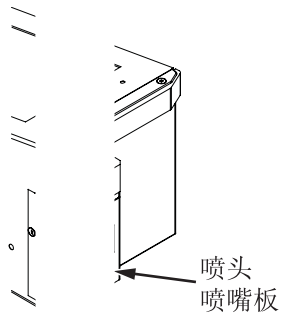

-Videojet 2340

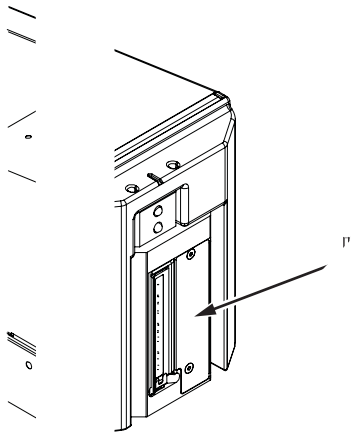

videojet 2350

5

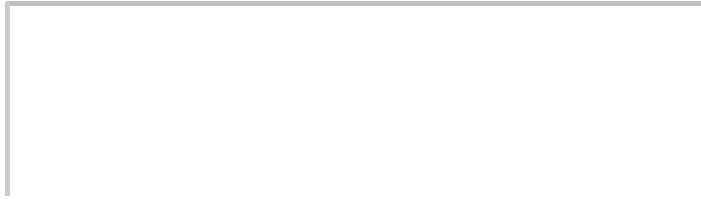

-
-
-
-
-
-
-
-
-

/

5-6

5-5

1

5-2

5-1

5-2

5-2



5-1

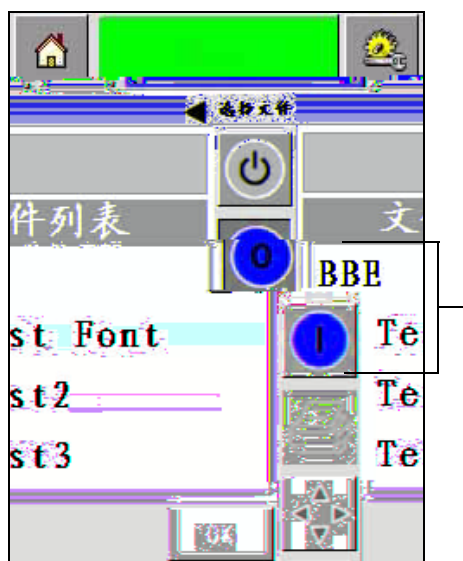

5-2

2

5-3

3

•

5-4

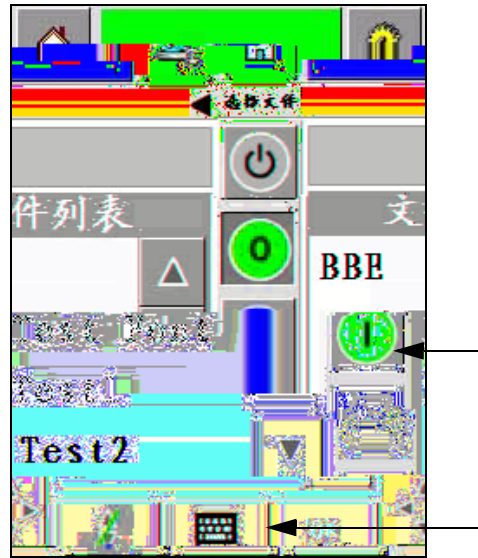

5-4

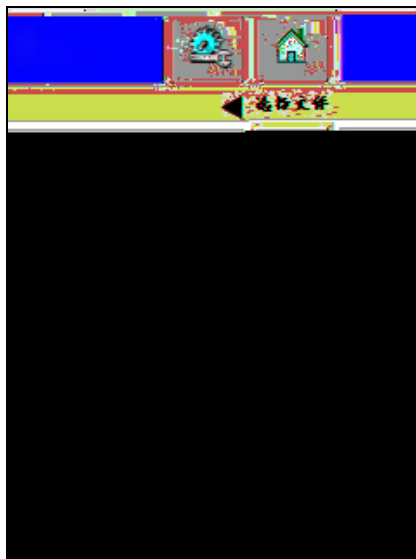

5-5

4

CLARITY®

5-6

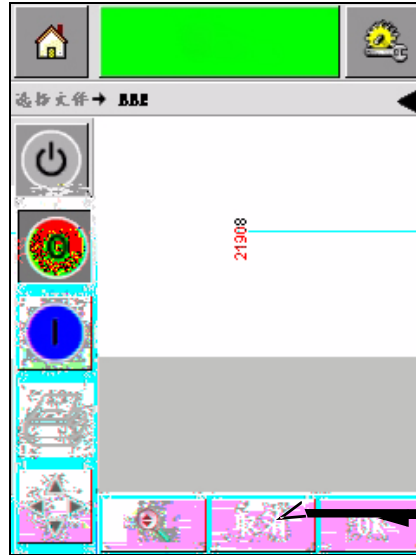

5-6

5

5-6

6

5-6

"

"

CLARITY®

CLARITY®

5-6

5-7

CLARITY®

5-7

5-7

BBE1

"

"

BBE1 " "

1

2004 3 11
5-7



5-7

2

5-8

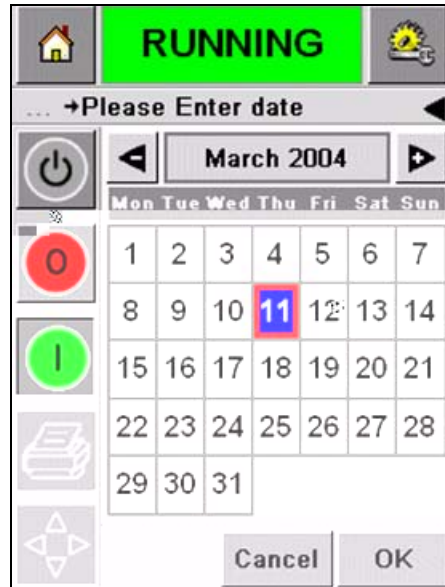

5-8

-  
-

5-8

3

4 CLARITY®

5-8

5-9



5-9

5

5-10

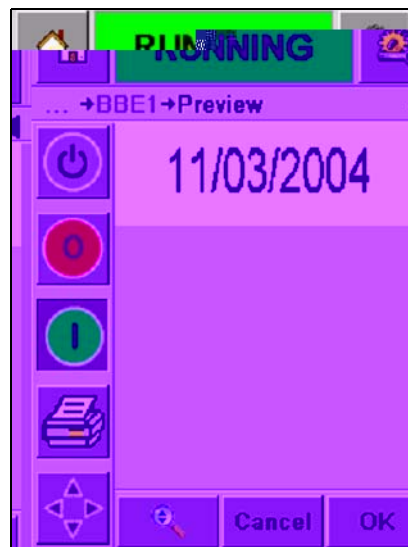

5-10

6

5-11



5-11

2340/2350/2360

5-12

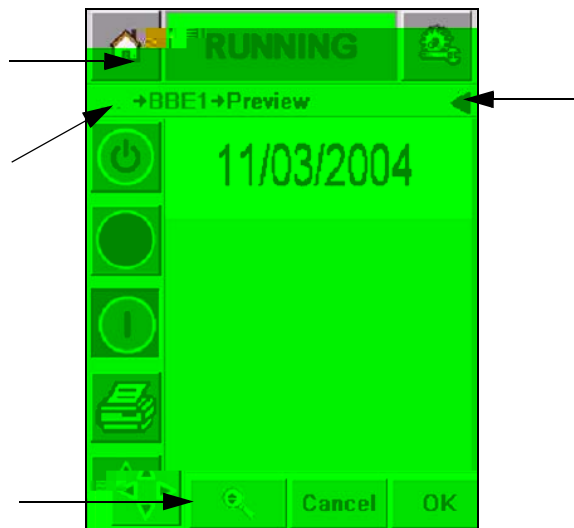

5-12

5-12

/

5-13

5-13

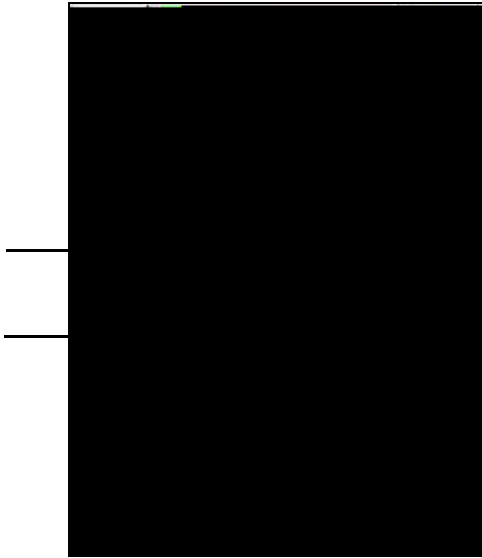

5-13

-
-
-
-

A B

4-14

"

"

/

1

> >

5-14



5-14

2

5-12

5-15



-

5-12

5-16

-

5-13

5-17

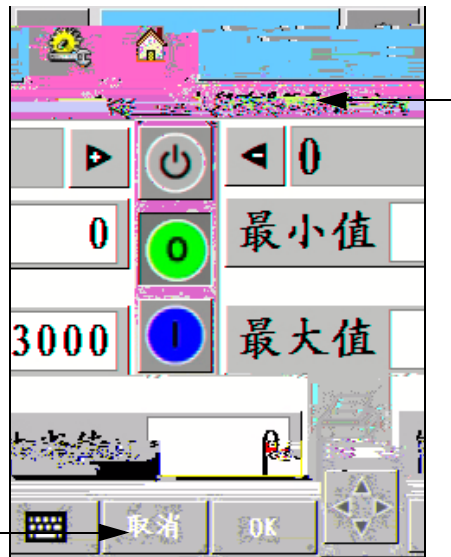

5-15

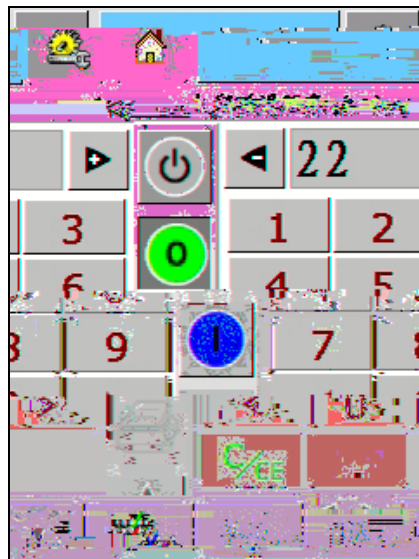

5-16



5-17

3

2340/2350/2360

10

1 > >
5-18

2



5-18

5-14

5-19

CLARITY®



5-19

CLARITY®

5-19

CLARITY®

5-15

5-20



5-20

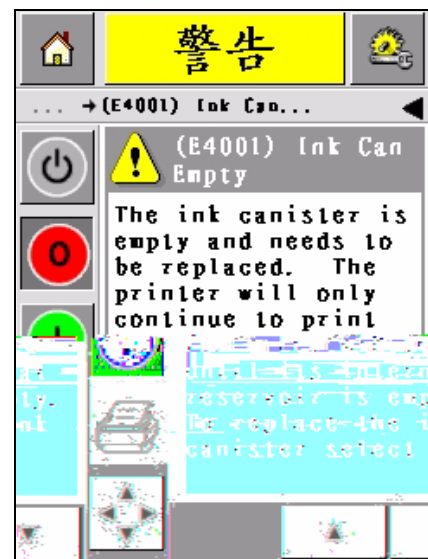

CLARITY®

5-21

5-21

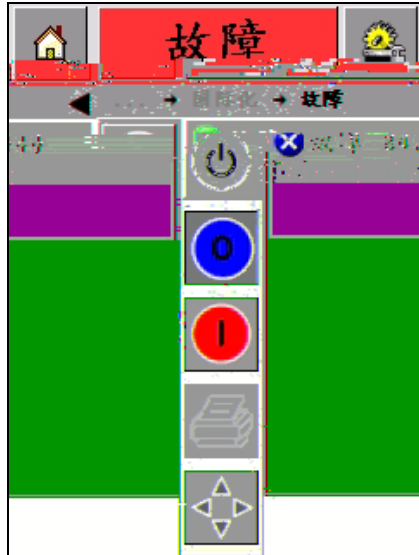

5-21

CLARITY®

LED

CLARITY®

5-17

5-22

CLARITY®

5-17

5-22

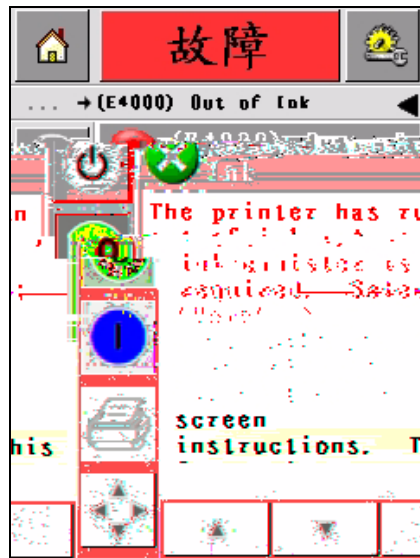

5-22

" "

CLARITY®

1

> >

5-23



5-23

2

5-23

3

5-19

5-24

4



5

6

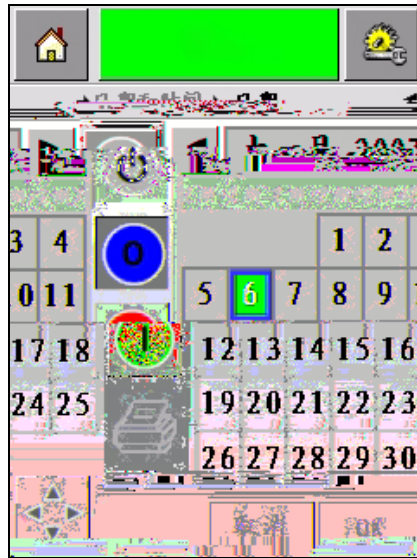

5-24

7

5-25

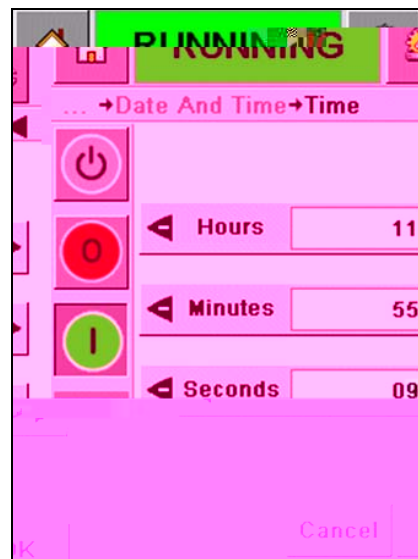

5-25

8



9

10

CLARiTY®

Month Day Year

Day Month Year

1

> > >

5-26



5-26

2

5-21

5-27



5-27

3

4 /

5

5-20

5-26

5-28



5-28 /

6

7